

WOOD - PRICELIST 2018 Euro

The prices are for the final users

VAT not included

"WOOD STANDARD": WOODEN FRAME PARASOL - Central Pole

Cod	Shape	Dimension	Pole Ømm	VAT not included			
				Polyester 220 gr/m	Polyacrylic 310gr/m	Acrylic 350 gr/m	Cover Bag
UPSR3	Round	Ø 3 m	Ø 48 mm	240	260	310	38
UPSR35	Round	Ø 3,5 m	Ø 58 mm	300	330	390	48
UPSR4	Round	Ø 4 m	Ø 58 mm	350	380	450	48
UPSP3	Square	3x3 m	Ø 58 mm	310	340	410	48
UPSP35	Square	3,5x3,5 m	Ø 58 mm	430	460	550	48
UPSP4	Square	4x4 m	Ø 58 mm	-	550	680	56
UPSD23	Rectangular	2x3 m	Ø 48 mm	260	280	340	48
UPSD34	Rectangular	3x4 m	Ø 58 mm	420	440	530	48

Parasol with fine European Ash wood frame, painted Iroko colour and treated for outdoor use
 Can be easily opened with pulley. Waterproofed fabrics, guaranteed for use in all conditions.

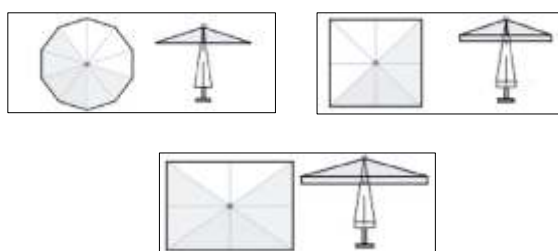

"WOOD TELESCOPIC": WOODEN FRAME PARASOL Telescopic System

Cod	Shape	Dimension	Pole Ømm	VAT not included			
				Polyester 220 gr/m	Polyacrylic 310gr/m	Acrylic 350 gr/m	Cover Bag
UPPT35	Square	3,5x3,5 m	Ø 58 mm	-	500	600	48
UPPT4	Square	4x4 m	Ø 58 mm	-	630	760	56
UPDT34	Rectangular	3x4 m	Ø 58 mm	-	490	590	48

Parasol with fine European Ash wood frame, painted Iroko colour and treated for outdoor use. Equipped with telescopic system which easily allows opening and closing over tables and chairs. Waterproofed fabrics, guaranteed for use in all conditions. Intchangeable ribs sec. 18x36mm



"WOOD SIDE ARM": WOODEN FRAME PARASOL - Side Arm

Cod	Shape	Dimension	Pole mm	VAT not included			
				Polyester 220 gr/m	Polyacrylic 310gr/m	Acrylic 350 gr/m	Cover Bag
UPBR35	Round	Ø 3,5 m	92x82 mm	840	880	960	48
UPBP3	Square	3x3 m	92x82 mm	840	880	960	48
UPBP35	Square	3,5x3,5 m	92x82 mm	1030	1070	1180	48
UPBP4	Square	4x4 m	92x92 mm	-	1360	1500	56
UPBD34	Rectangular	3x4 m	92x82 mm	1010	1050	1160	48

Parasol with side arm frame and laminated wood lateral pole in Iroko colour.

Hand crank opening mechanism, with clutch for professional use. Waterproofed fabrics, guaranteed for use in all conditions.

Including metal base system which rotates 360° (Concrete plates 50x50 cm not included)

Metal components grey anthracite epoxy coated for outdoor use. Intchangeable ribs sec. 18x36mm



WOOD - PRICELIST 2018 Euro

"WOOD POKER": WOODEN FRAME PARASOL - Multiarms

Cod	Shape	Dimension	Pole mm	VAT not included				
				Poliestere 310 gr/m	Polyacrylic 310 gr/m	Acrylic 350 gr/m	Gutters	Cover Bag
UPP36	Rectangular	3x6 m	120x120 mm	-	2380	2510	80	96
UPP37	Rectangular	3,50x7 m	120x120 mm	-	2790	2950	80	96
UPP66	Square	6x6 m	120x120 mm	-	3900	4160	320	192
UPP77	Square	7x7 m	120x120 mm	-	4500	4820	320	192

Multiarm parasol in laminated wooden frame, Iroko colour: available for 2 or 4 parasols

Hand crank opening mechanism, with clutch for professional use. Waterproofed fabrics, guaranteed for use in all conditions. Including metal base (Concrete plates 50x50 cm not included)

Metal components grey anthracite epoxy coated for outdoor use. Intchangeable ribs sec. 18x36mm

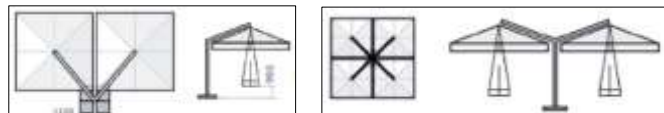

"WHITE WOOD STANDARD": BLEACHED WOODEN FRAME PARASOL - Central Pole

Cod	Shape	Dimension	Pole mm	VAT not included			
				Polyester 220 gr/m	Polyacrylic 310 gr/m	Acrylic 350 gr/m	Cover Bag
UPWR3	Round	Ø 3 m	Ø 48 mm	-	320	380	38
UPWR35	Round	Ø 3,5 m	Ø 58 mm	-	400	480	48
UPWR4	Round	Ø 4 m	Ø 58 mm	-	470	550	48
UPWP3	Square	3x3 m	Ø 58 mm	-	410	490	48
UPWP35	Square	3,5x3,5 m	Ø 58 mm	-	540	640	48
UPWD34	Rectangular	3x4 m	Ø 58 mm	-	520	620	48

Parasol with fine European bleached Ash wood frame, treated for outdoor use

Can be easily opened with pulley. Waterproofed fabrics, guaranteed for use in all conditions.

Intchangeable ribs sec. 18x36mm



"WHITE WOOD TELESCOPIC": BLEACHED WOODEN FRAME PARASOL - Telescopic System

Cod	Shape	Dimension	Pole mm	VAT not included			
				Polyester 220 gr/m	Polyacrylic 310 gr/m	Acrylic 350 gr/m	Cover Bag
UPWBR35	Round	Ø 3,5 m	92x82 mm	-	1120	1200	48
UPWBP3	Square	3x3 m	92x82 mm	-	1140	1220	48
UPWBP35	Square	3,5x3,5 m	92x82 mm	-	1340	1440	48
UPWBD34	Rectangular	3x4 m	92x82 mm	-	1320	1420	48

Parasol with fine European bleached Ash wood frame, and treated for outdoor use. Equipped with telescopic system which easily allows

opening and closing over tables and chairs. Waterproofed fabrics, guaranteed for use in all conditions. Intchangeable ribs sec. 18x36mm



"WHITE WOOD SIDE ARM": BLEACHED WOODEN FRAME PARASOL - Side Arm

Cod	Shape	Dimension	Pole mm	VAT not included			
				Polyester 220 gr/m	Polyacrylic 310 gr/m	Acrylic 350 gr/m	Cover Bag
UPWBR35	Round	Ø 3,5 m	92x82 mm	-	1120	1200	48
UPWBP3	Square	3x3 m	92x82 mm	-	1140	1220	48
UPWBP35	Square	3,5x3,5 m	92x82 mm	-	1340	1440	48
UPWBD34	Rectangular	3x4 m	92x82 mm	-	1320	1420	48

Parasol with side arm frame. Lateral pole in laminated wood, pole and ribs in beached wood.

Hand crank opening mechanism, with clutch for professional use. Waterproofed fabrics, guaranteed for use in all conditions.

Including metal base system which rotates 360° (Concrete plates 50x50 cm not included)

Metal components grey anthracite epoxy coated for outdoor use. Intchangeable ribs sec. 18x36mm



ALUMINIUM - PRICELIST 2018 Euro

"ALUMINIUM STANDARD": ALUMINIUM FRAME PARASOL - Central Pole

Cod	Shape	Dimension	Pole mm	VAT not included			
				Polyester 220 gr/m	Polyacrylic 310 gr/m	Acrylic 350 gr/m	Cover Bag
UNSR3	Round	Ø 3 m	Ø 50 mm	290	310	360	38
UNSR35	Round	Ø 3,5 m	Ø 50 mm	340	370	430	48
UNSR4	Round	Ø 4 m	Ø 50 mm	380	420	490	48
UNSP3	Square	3x3 m	Ø 50 mm	380	410	480	48
UNSP35	Square	3,5x3,5 m	Ø 50 mm	470	520	610	48
UNSD34	Rectangular	3x4 m	Ø 50 mm	460	510	600	48

Aluminium frame parasol grey anthracite epoxy coated for outdoor use. Can be easily opened with pulley.
 Waterproofed fabrics, guaranteed for use in all conditions. Intchangeable ribs sec. 15x30mm



"ALUMINIUM TELESCOPIC": ALUMINIUM FRAME PARASOL - Telescopic System

Cod	Shape	Dimension	Pole mm	VAT not included			
				Polyester 220 gr/m	Polyacrylic 310 gr/m	Acrylic 350 gr/m	Cover Bag
UNTP35	Square	3,5x3,5 m	Ø 50 mm	520	570	660	48
UNTP4	Square	4x4 m	Ø 55 mm	-	730	860	56
UNTD34	Rectangular	3x4 m	Ø 50 mm	510	560	650	48

Aluminium frame parasol grey anthracite epoxy coated for outdoor use. Equipped with telescopic system which easily allows opening and closing over tables and chairs. Waterproofed fabrics, guaranteed for use in all conditions. Intchangeable ribs sec. 15x30mm

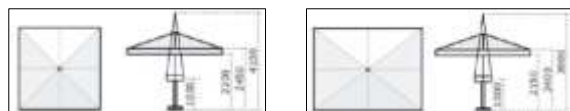

"ALUMINIUM SIDE ARM": ALUMINIUM FRAME PARASOL - Side Arm

Cod	Shape	Dimension	Pole mm	VAT not included			
				Polyester 220 gr/m	Polyacrylic 310 gr/m	Acrylic 350 gr/m	Cover Bag
UNBR35	Round	Ø 3,5 m	82x82 mm	890	930	1020	48
UNBP3	Square	3x3 m	82x82 mm	890	930	1000	48
UNBP35	Square	3,5x3,5 m	82x82 mm	1070	1120	1210	48
UNBP4	Square	4x4 m	92x92 mm	-	1440	1570	48
UNBD34	Rectangular	3x4 m	82x82 mm	1050	1100	1190	48

Parasol with side arm frame. Lateral pole and ribs in aluminium, grey anthracite epoxy coated for outdoor use.
 Hand crank opening mechanism, with clutch for professional use. Waterproofed fabrics, guaranteed for use in all conditions.
 Including metal base system which rotates 360° (Concrete plates 50x50 cm not included)
 Metal components grey anthracite epoxy coated for outdoor use. Intchangeable ribs sec. 15x30mm

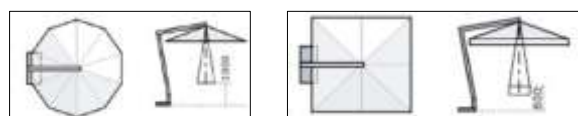

ALUMINIUM - PRICELIST 2018 Euro

"ALUMINIUM POKER": ALUMINIUM FRAME PARASOL - Multiarms

Cod	Shape	Dimension	Pole mm	VAT not included				
				Polyester 220 gr/m	Polyacrylic 310 gr/m	Acrylic 350 gr/m	Gutters	Cover Bag
UNPD36	Rectangular	3x6 m	100x100 mm	-	2380	2510	80	96
UNPD37	Rectangular	3,5x7 m	100x100 mm	-	2790	2950	80	96
UNPP66	Square	6x6 m	100x100 mm	-	3900	4160	320	192
UNPP77	Square	7x7 m	100x100 mm	-	4500	4820	320	192

Multiarm parasol in aluminium frame, grey anthracite epoxy coated for outdoor use: available for 2 or 4 parasols.
 Hand crank opening mechanism, with clutch for professional use. Waterproofed fabrics, guaranteed for use in all conditions.
 Including metal base (Concrete plates 50x50 cm not included)
 Metal components grey anthracite epoxy coated for outdoor use. Intchangeable ribs sec. 15x30mm

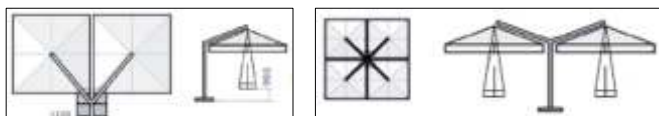

"ALUMINIUM RETRACTABLE": ALUMINIUM UMBRELLA - Retractable Arm

Cod	Shape	Dimension	Pole mm	VAT not included		
				Polyacrylic 310 gr/m	Acrylic 350 gr/m	Cover Bag
UNRP3	Square	3x3 m	115x65 mm	1440	1520	70
UNRP35	Square	3,5x3,5 m	115x65 mm	1650	1720	70
UNRD34	Rectangular	3x4 m	115x65 mm	1650	1720	70
UNRP4	Square	4x4 m	115x65 mm	2060	2190	70
UNRR35	Round	ø3,5 m	115x65 mm	1440	1510	70

Parasol with side arm frame. Lateral pole and ribs in aluminium, grey anthracite epoxy coated for outdoor use.
 Hand crank opening mechanism, with clutch for professional use. Waterproofed fabrics, guaranteed for use in all conditions.
 Including metal base system which rotates 360° (Concrete plates 50x50 cm not included)
 Metal components grey anthracite epoxy coated for outdoor use. Intchangeable ribs sec. 15x30mm



"ALUMINIUM RETRACTABLE": ALUMINIUM RETRACTABLE PARASOL - Multiarms

Cod	Shape	Dimension	Pole mm	VAT not included				
				Polyester 220 gr/m	Polyacrylic 310 gr/m	Acrylic 350 gr/m	Gutters	Cover Bag
UNRPP6	Square	6x6 m	100x100 mm	-	4600	4880	320	300
UNRPP7	Square	7x7 m	100x100 mm	-	5450	5770	320	320
UNRPP8	Square	8x8 m	100x100 mm	-	7200	7600	340	360
UNRPD68	Rectangular	6x8 m	100x100 mm	-	5990	6310	320	320
UNRPD36	Rectangular	3x6 m	100x100 mm	-	3800	3940	80	260
UNRPD38	Rectangular	3x8 m	100x100 mm	-	5200	5360	80	280
UNRPD35/7	Rectangular	3,5x7 m	100x100 mm	-	4300	4460	80	280
UNRPD48	Rectangular	4x8 m	100x100 mm	-	5960	6160	90	300

The Multi-arm Retractable Umbrella is provided with a revolutionary mechanism, unique in the world. Starting from now, one person can open and close all 4 umbrellas in one minute, using a centralized mechanism. You have the opportunity to act quickly under stormy and high wind conditions.

The umbrella is provided with a highly resistant aluminum structure, with a central pillar of 100 mm in diameter. The entire system can be easily mounted and dismounted. The covers and arms close completely around the central pillar, minimizing the space they occupy. If the umbrella is provided with gutters, they no longer should be disposed of in the process of shutting down.

The umbrella can be left out during the winter, protected by a cover bag, because it doesn't take much space.

The price includes the umbrella's metal base.



"ALUMINIUM GIANT" ALUMINIUM FRAME PARASOL - Big Dimensions

Cod	Shape	Dimension	Pole mm	VAT not included			
				Polyester 220 gr/m	Polyacrylic 310 gr/m	Acrylic 350 gr/m	Cover Bag
UCD45	Rectangular	4x5 m	Ø 100 mm	-	2100	2260	92
UCD55	Rectangular	4,5x5,5 m	Ø 100 mm	-	2220	2430	92
UCP5	Square	5x5 m	Ø 100 mm	-	2120	2320	92
UCP6	Square	6x6 m	Ø 100 mm	-	2730	2990	92

Big size parasol in aluminium frame, grey anthracite epoxy coated for outdoor use. Ribs and pole made in bigger section and thickness, according to dimensions. Equipped with telescopic system which easily allows opening and closing over tables and chairs. Waterproofed fabrics, guaranteed for use in all conditions. Intechangeable ribs sec. 18x36mm



IMPORTANT TO KNOW

- 1) The umbrella covers: are standard; with a skirt for square and rectangular, without a skirt for round, unless otherwise requested. Colors are standard and ecru, unless otherwise requested.
- 2) All side arm umbrellas are easily installed, without the help of a ladder, with a screw key of 10, 13, 19 mm or adjustable. For the Poker umbrellas with 4-2 arms there is a need for a ladder of height ±2 m.
- 3) On request the bases and accessories made of iron will be pre galvanized, painted and provided with stainless steel screws (with cost adjustment).

SIDE ARM PARASOL MOUNTING

The mounting takes place in the following order:

- The tub (2) is raised over the base (1). Then the pipe (3), with pole (3) and arm (5) are joined together . Together (5)-(4)-(3) are raised on the tube (2).
- Then take the umbrella, join the two cables and hook it on the top of the arm (5). The umbrella will then opened with the crank. There is a rib (8) on the pole (4). They have to be screwed together in order to give stability to the umbrella.

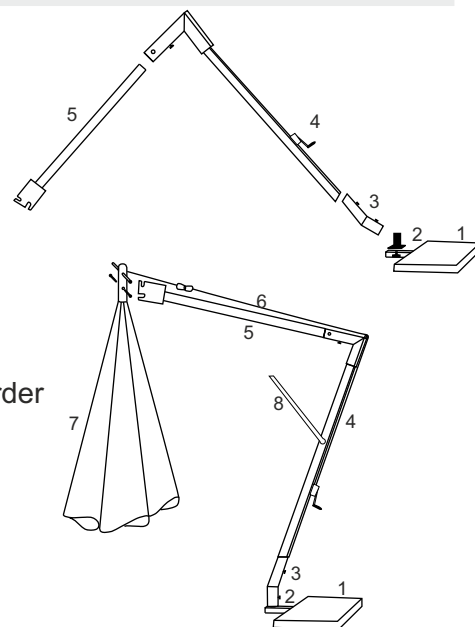

RETRACTABLE UMBRELLA MOUNTING

Mounting takes place in the following order:

- Tube (2) with base (1).
- The tube (3) is screwed on the pole (4) and together are raised on the tube (2). Tighten the screws that are already included on the tube (3).

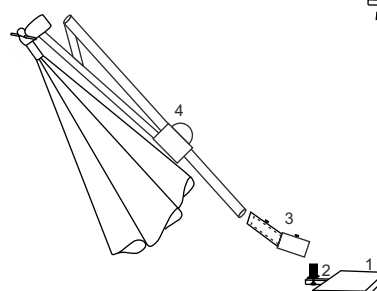

"ADVERTISING PARASOL": BRANDED PARASOLS

Scolaro International is highly specialized to customize all parasol production in wooden and aluminium frame because combines manufacturing capacity (it's equipped with four-colour printing plant CMYK) with availability to meet all customer needs.

All models may be advertised, ask for a free offer.



BASES-ACCESSORIES - PRICELIST 2018

"BASES": BASES AND ACCESSORIES

Cod	Description	Weight	Material	VAT not included
BRC35	Round+TFØ55 or TFØ65	35 kg	Cement/Grit	48
BRC55	Round+TFØ55 or TFØ65	55 kg	Cement/Grit	54
BRC55M	Round+TFØ55 or TFØ65+Handles	55 kg	Cement/Grit	72
BRC75M	Round+TFØ55 or TFØ65+Handles	75 kg	Cement/Grit	100
BQC12	Square 40x40x4 cm	12 kg	Cement/Grit	11
BQC20	Square 50x50x4 cm	20 kg	Cement/Grit	14
BQC60M	Square 50x50x11 cm+Handles	60 kg	Cement/Grit	72
VC80M	Square Vase 50x50 cm+Handles	80 kg	Cement/Grit	100
BCF	Cross Bar+TFØ55 or TFØ65	10 kg	Galvanized metal	48
BCF100	Cross Bar 100x100 cm	15 kg	Galvanized metal	220
TF55	Tube Ø 55mm	1 kg	Galvanized metal	19
TF65	Tube Ø 65 mm	1 kg	Galvanized metal	19
BLF	Lamellar wood vase 110x50x32 cm	20 kg	Lamellar wood	350

Available bases: round, square and flowerpot, in cement/grit.

Cross base in galvanized metal can be used for cement/grit tiles 40x40 or 50x50 cm

All bases are supplied with tube Ø55mm or Ø65mm



GAZEBOS - PRICELIST 2018 Euro

"PROFESSIONAL MODEL": PROFESSIONAL GAZEBOS

Cod	Dimension	Framework	Wheigh	Packaging size	Cover	VAT not included
GFQ3	3x3 m Square	Metal	32 kg	30x30x160 cm	Polyester 280 gr/m	360
GFR34	3x4,5 m Rettang.	Metal	38 kg	30x40x160 cm	Polyester 280 gr/m	570
GFR36	3x6 m Rettang.	Metal	65 kg	30x50x160 cm	Polyester 280 gr/m	800
GAP3	3x3 m Square	Aluminium	27 kg	30x30x160 cm	Polyester 280 gr/m	460
GAD34	3x4,5 m Rettang.	Aluminium	32 kg	30x40x160 cm	Polyester 280 gr/m	660
GAP36	3x6 m Rettang.	Aluminium	38 kg	35x45x160 cm	Polyester 280 gr/m	780
GAD44	4x4 m Square	Aluminium	32 kg	35x35x210 cm	Polyester 280 gr/m	590
GAEP3	3x3 m Square	Aluminium Extra	35 kg	40x40x167 cm	Polyester 280 gr/m	798
GAED34	3x4,5 m Rettang.	Aluminium Extra	50 kg	40x50x167 cm	Polyester 280 gr/m	-
GAED36	3x6 m Rettang.	Aluminium Extra	70 kg	50x60x167 cm	Polyester 280 gr/m	1120
GAEP44	4x4 m Rettang.	Aluminium Extra	50 kg	33x37x210 cm	Polyester 280 gr/m	840
GAED46	4x6 m Rettang.	Aluminium Extra	70 kg	44x37x210 cm	Polyester 280 gr/m	1140
GAED48	4x8 m Rettang.	Aluminium Extra	82 kg	60x37x210 cm	Polyester 280 gr/m	1480

Iron and aluminium folding framework with telescopic legs, light grey epoxy coated for outdoor use. Easy opening and closing. Cover in polyester waterproof fabric, bag for transport included. Strong, stable, handy and comfortable: suitable for commercial and professional use. All models may be advertised, ask for a free offer.



"PROMOTIONAL MODEL": PROMOTIONAL MODEL

Cod	Dimension	Weigh	Framework	Packaging size	Cover	VAT not included
GPFP2	2x2 m Square	18 kg	Metal	20x20x125 cm	Polyester 220 gr/m	176
GPFP3	3x3 m Square	26 kg	Metal	23x23x130 cm	Polyester 220 gr/m	270

Iron folding framework with telescopic legs, easy opening and closing, light grey epoxy coated for outdoor use. Easy opening and closing. Cover in polyester waterproof fabric, bag for transport included. All models may be advertised, ask for a free offer.

"FABRIC SIDE WALLS": FOR GAZEBOS

Cod	Dimens HxL	Fabric	Euro VAT not included
GL22	2x2 m	Polyester 220gr/m	48
GL23	2x3 m	Polyester 220gr/m	64
GL24	2x4 m	Polyester 220gr/m	84
GL2/45	2x4,5 m	Polyester 220gr/m	90
GL26	2x6 m	Polyester 220gr/m	122
GL28	2x8 m	Polyester 220gr/m	154



All models may be advertised, ask for a free offer.

SPARE PARTS - PRICELIST 2018 Euro

"COVERINGS": FOR PARASOLS

Cod	Parasol	Description	Vat not included		
			Polyester 220 gr/m	Polyacrylic 310gr/m	Acrylic 350 gr/m
CPR3	Ø 3 m	Round	104	124	174
CPR35	Ø 3,5 m	Round	120	150	210
CPR4	Ø 4 m	Round	140	170	240
CPP3	3x3 m	Square	128	160	230
CPP35	3,5x3,5 m	Square	168	208	288
CPP44	4x4 m	Square	-	260	360
CPD34	3x4 m	Rectangular	158	208	288
CPP55	5x5 m	Square	-	460	640
CPD45	4x4 m	Rectangular	-	430	580
CPD45/55	4,5x5,5 m	Rectangular	-	460	640
CPP66	6x6 m	Square	-	990	1250

"RIBS": FOR PARASOLS

Cod	Parasol	Description	Vat not included		
			Wood	White Wood	Aluminium
BR3	Ø 3 m	Round	16	22	22
BR35	Ø 3,5 m	Round	22	26	26
BR4	Ø 4 m	Round	24	28	28
BP3	3x3 m	Square	24	28	28
BP35	3,5x3,5 m	Square	32	36	36
BP44	4x4 m	Square	48	56	56
BD34	3x4 m	Rectangular	32	36	36
BD55	5x5 m	Square	-	-	120
BD66	6x6 m	Square	-	-	140

GAZEBO PAGODA - PRICELIST 2018

"GAZEBO PAGODA"		Euro - VAT not included	
Cod	Dimension	Polyacrylic 220 gr	Acrylic 330 gr
PGD4	4x4 m	1120	1270
PGD5	5x5 m	1300	1540
PGD55	5,5x5,5 m	1400	1680
PGD6	6x6 m	1660	1990
PGD7	7x7 m	2120	2560

All models may be advertised, ask for a free offer.



SAHARA TENT - PRICELIST 2018

"SAHARA"	Euro - VAT not included		Dimensions	Occupied space
	Polyacrylic 310 gr	Acrylic 350 gr		
SHA4	470	520	4x4 m	11x8 m
SHA5	610	670	5x5 m	12x9 m
SHA6	730	800	6x6 m	14x11 m

All models may be advertised, ask for a free offer.



AFRICAN TENT - PRICELIST 2018

"AFRICAN TENT"

Dimensions	Places to sit at the table	Places to stand	Description	Prices
48 m ² (8 x 6)	15 - 20	30	– product presentation or selling, DJ or a mini-bar on the beach.	€ 1800
78 m ² (10,5 x 7,5)	25 - 30	45	– for outdoor events, a large bar on the beach or as a cover for the picnic area.	€ 2300
108 m ² (12 x 9)	35 - 40	60	– for large scale activities, terrace on the beach or a restaurant extension.	€ 3300
157 m ² (15 x 10,5)	60 - 65	100	– suitable for seminars or covering a stage for various events.	€ 4600
210 m ² (20 x 10,5)	100 - 110	150	– for a large auditorium, exhibition or product presentation.	€ 6800



MODULAR SCREENS - PRICELIST 2018

"MODULAR SCREENS"

Cod	Dimensions	Price/Unity
PVV1	70x160 cm	420
PVV2	135x160 cm	550
PVR1	70x160 cm	420
PVR2	100x160 cm	450

Euro - VAT not included

All models may be advertised, ask for a free offer.

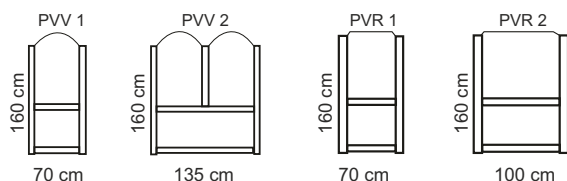

The screen is made as a modular aluminum skeleton (52 x 52 cm), hot painted, and it can be closed according to your choice with a glass panel or with a plastic panel. It can be easily be assembled, disassembled or modified.

FOLDING TABLE WITH CHAIRS - PRICELIST 2018

"FOLDING TABLE WITH CHAIRS"

	Price
Folding Chairs	96
Rectangulat table 120 x 70	240
Square table 70 x 70	220
Round table ø92	235

Euro - VAT not included

All models may be advertised, ask for a free offer.



PUB SET - PRICELIST 2018 Euro

"PUB SET"

Table dimensions	Prices
220 x 50	€ 170
220 x 60	€ 190
220 x 70	€ 200
220 x 80	€ 240
200 x 60	€ 176

Euro - VAT not included

All models may be advertised, ask for a free offer.



GENERAL TERM OF SALE

- For professional users or wholesalers we have adequate conditions.
- Prices are quoted to the public in Euros, excluding VAT
- All models can be customized (advertising prints, colors, etc.) and will be confirmed after the customer accepts the offer.
- Orders that are sent to us are always subject to our approval.
- The transportation cost will be calculated according to your order.
- Even if free at destination, the goods travel at the risk of the carrier.
- The delivery date is indicative and in any case we can not be held responsible for delays in deliveries caused by force majeure beyond our control (strikes, irregularities transport, etc.)
- We reserve the right to make improvements to the products without prior notice.
- Any complaints must be received by registered letter within 8 days of receipt of goods. Any dispute will be settled by the Court of Padua